

INTER-FAB
inter-fab.com

WILD RIDE™ SLIDE
Assembly & Installation Instructions

IMPORTANT
THESE INSTRUCTIONS
MUST REMAIN WITH
THE SLIDE OWNER!



3050 S. ALVERNON WAY • TUCSON, AZ 85713
520.790.7040 • 800.737.5386 • FAX 520.790.7127

inter-fab.com

TABLE OF CONTENTS:

Intended Use Instructions 2

Water Safety Envelope..... 3

Slide Placement & Footprint Diagrams - Left Turn..... 4

Slide Placement & Footprint Diagrams - Right Turn..... 5

Tips & Tools for Slide Assembly 6

Step 1: Measure the Pool..... 7

Step 2: Flume Assembly 7

Step 3: Legs to Flume Assembly..... 7

Step 4: Attach Deck Anchors to Legs..... 8

Step 5: Assemble Steps 8

Step 6: Stand Up the Slide..... 8

Step 7: Attach “L” Brackets to Steps..... 8

Step 8: Align Flume Sections..... 8

Step 9: Attach Handrails to Steps..... 9

Step 10: Attach Steps to Flume 9

Step 11: Place Slide in Final Position 10

Step 12: On Deck Installation 10

Step 13: In Deck Installation..... 10

Step 14: Attach Water Supply..... 11

Step 15: Attach Protective Caps..... 11

Step 16: Provide Homeowner with Owner’s Manual 11

Inspection Check List..... 11

Slide Care & Maintenance..... 12

Paver Kit Installation..... 13

Exploded View of White Water Slide 14

Parts List (corresponds with exploded view)..... 15

Hardware Kit Information..... 16

Notes..... 17

Inter-Fab, Inc. Limited Warranty..... 18

INTENDED USE INSTRUCTIONS

1. Everyone who uses this slide must know, understand and follow these instructions
2. The ANSI/NSPI-4 2007 standard for above ground pools prohibits the use of slides or diving boards on above ground pools.
3. **This Slide is designed for residential inground pool use ONLY. This slide may not be used on any above ground pool. Such use of this slide may result in serious injury or death.**
4. This slide should never be installed on above ground pools, ponds, floating docks or platforms, boat docks or houseboats or any natural body of water.
5. This slide should never be installed on any commercial, public or semi-public pool.
6. Be Familiar with the shape and depth of the pool before you slide. This slide should only be used with the proper water safety envelope, as described in Diagrams A, B and C page 3 and in accordance with the slide positioning instructions, as described in Diagrams D, E, F and G on pages 4 and 5.
7. Because the slide may only be used in water 1.22 m deep or greater, all slide users must be able to swim in deep water.
8. Weight limit for this slide is 113 kilos no slider weighing more than 113 kilos may use this slide.
9. The surface of the slide is very slippery when wet; **USE CAUTION** when entering the slide and when transitioning from standing to sitting.
10. Slide in a feet first sitting position **ONLY**.
11. **IMPORTANT: sliding headfirst is prohibited**: serious spinal injury resulting in paralysis or death can result.
12. Maintain adult supervision at all times.
13. Only one person at a time is allowed on the slide; this includes the ladder.
14. Be sure the water delivery system is on and lubricating the slide prior to use.
15. Collision with another swimmer or a diver can result in serious injury or death for one or both persons: Before sliding, always make sure that the path in front of the slide is free from any (including submerged) obstructions including other people or objects in the pool such as rafts, inner tubes etc. When a diving board is also present, make sure you do not use the slide while someone is on or using a diving board. Take turns.
16. No roughhousing or horseplay should be allowed on the slide at any time.
17. Do not stand, jump or dive from any part of the slide.
18. Do not slide on objects such as rafts or inner tubes. doing so greatly increases your risk of injury.
19. Do not slide through or at objects such as rafts or inner tubes, doing so greatly increases your risk of injury.
20. Do not use this slide if physically impaired or handicapped without your doctor's permission.
21. Do not use this slide with a history of heart conditions, seizures, back problems, fainting or fear of heights.
22. Do NOT use this slide if you are pregnant.
23. Do not drink alcohol and use this slide.
24. Don't take chances, inspect the slide at least once a year (see the slide inspection list on page 11), do not use the slide if any part becomes loose, damaged, weakened or broken. If necessary, before using the slide again, have it inspected and repaired by a competent professional familiar with pool slides.

WARNING: SERIOUS INJURY OR DEATH CAN RESULT FROM THE IMPROPER INSTALLATION OR USE OF THIS SLIDE.



When installed according to these instructions, this slide conforms to Consumer Product Safety Standard Guidelines.

WILD RIDE

NOTE: Inches are used in reference to SAE nut & bolt sizes

WATER SAFETY ENVELOPE:

A minimum water depth of one meter under the exit of the slide which increases to a depth of 1.25 meters at point A which is located 1.37 meters from the back wall of the pool. A minimum depth of 1.25 meters must be maintained at a distance of 2.75 meters along the centerline of the slide from point A. The above described water depth profile shall extend a minimum of 1 meter on either side of the centerline of the slide.

(See Diagrams A, B & C)

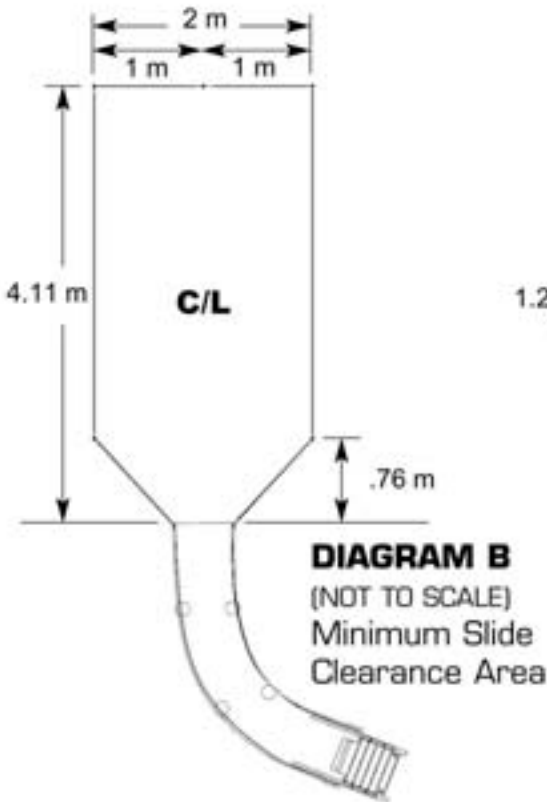
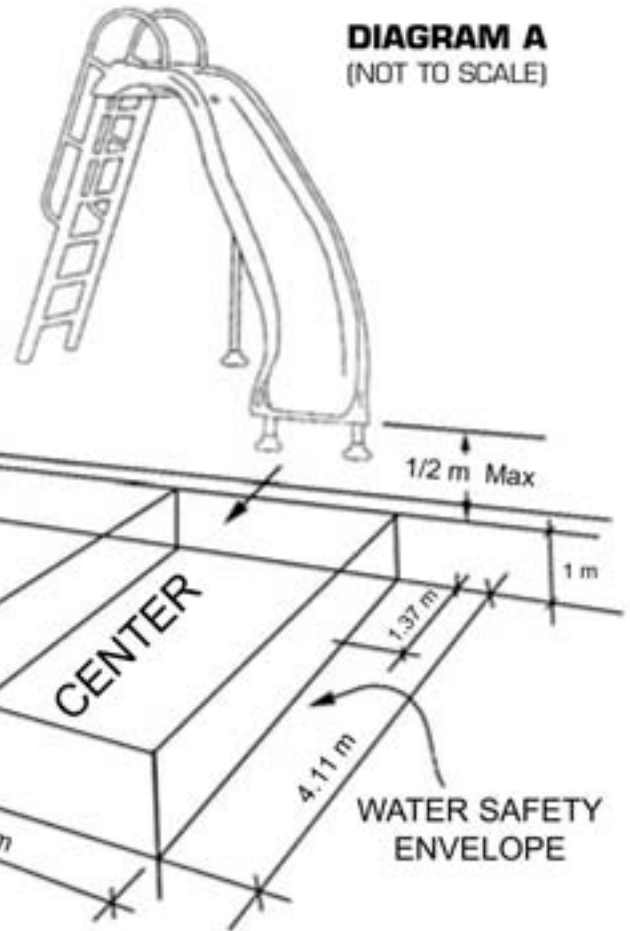
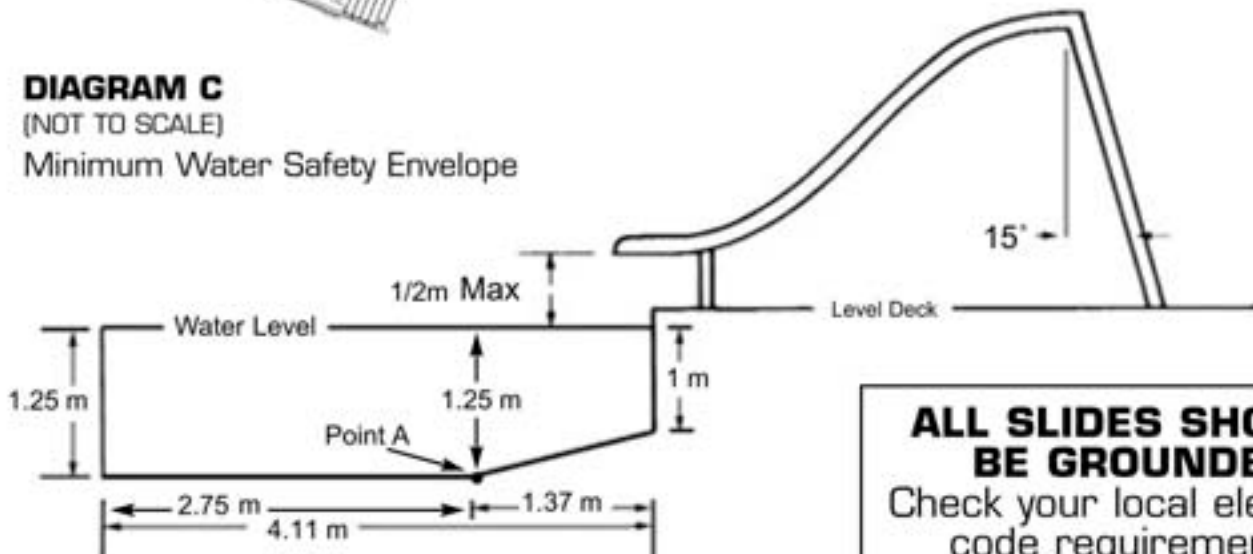

DIAGRAM C
(NOT TO SCALE)
Minimum Water Safety Envelope



ALL SLIDES SHOULD BE GROUNDED
Check your local electrical code requirements.

SLIDE PLACEMENT DIAGRAM & FOOTPRINT DIAGRAM

Wild Ride Slide - Left Turn

DIAGRAM D
(NOT TO SCALE)

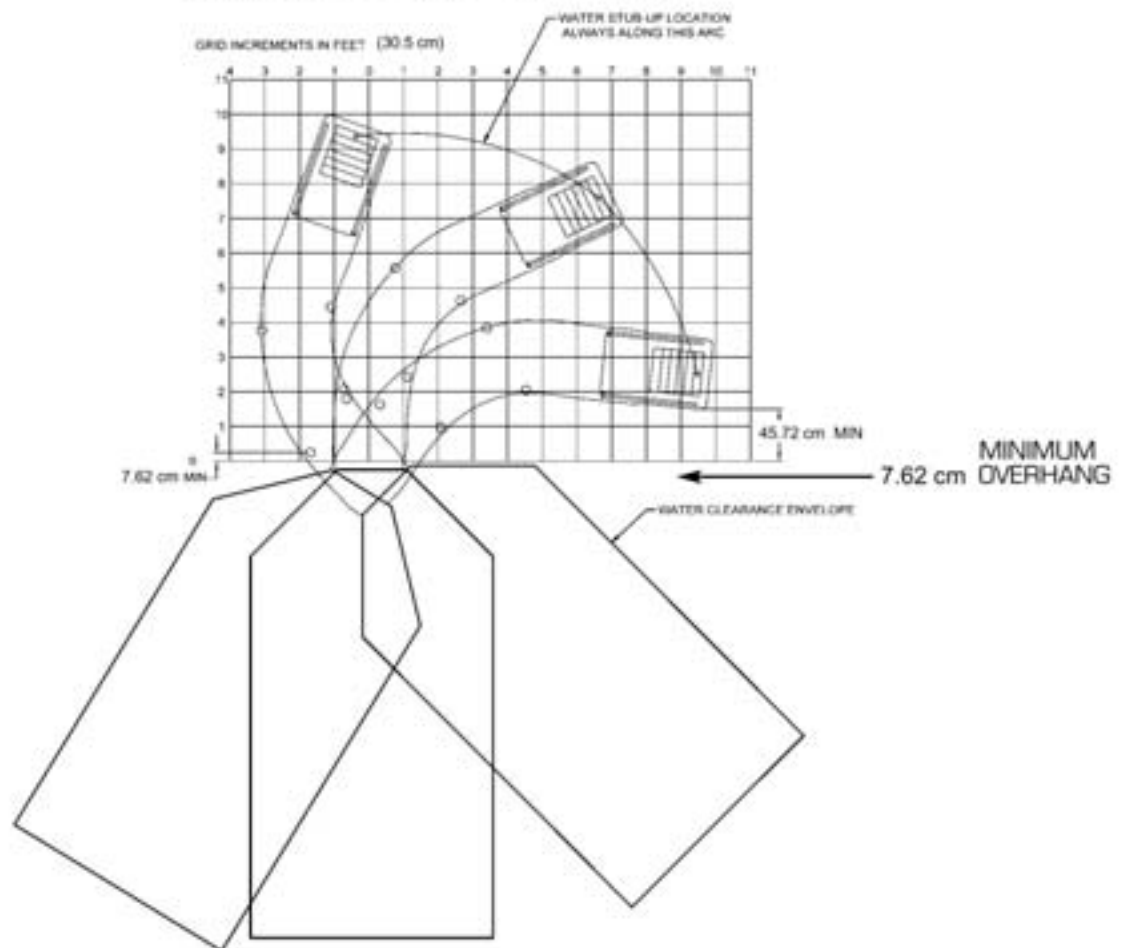
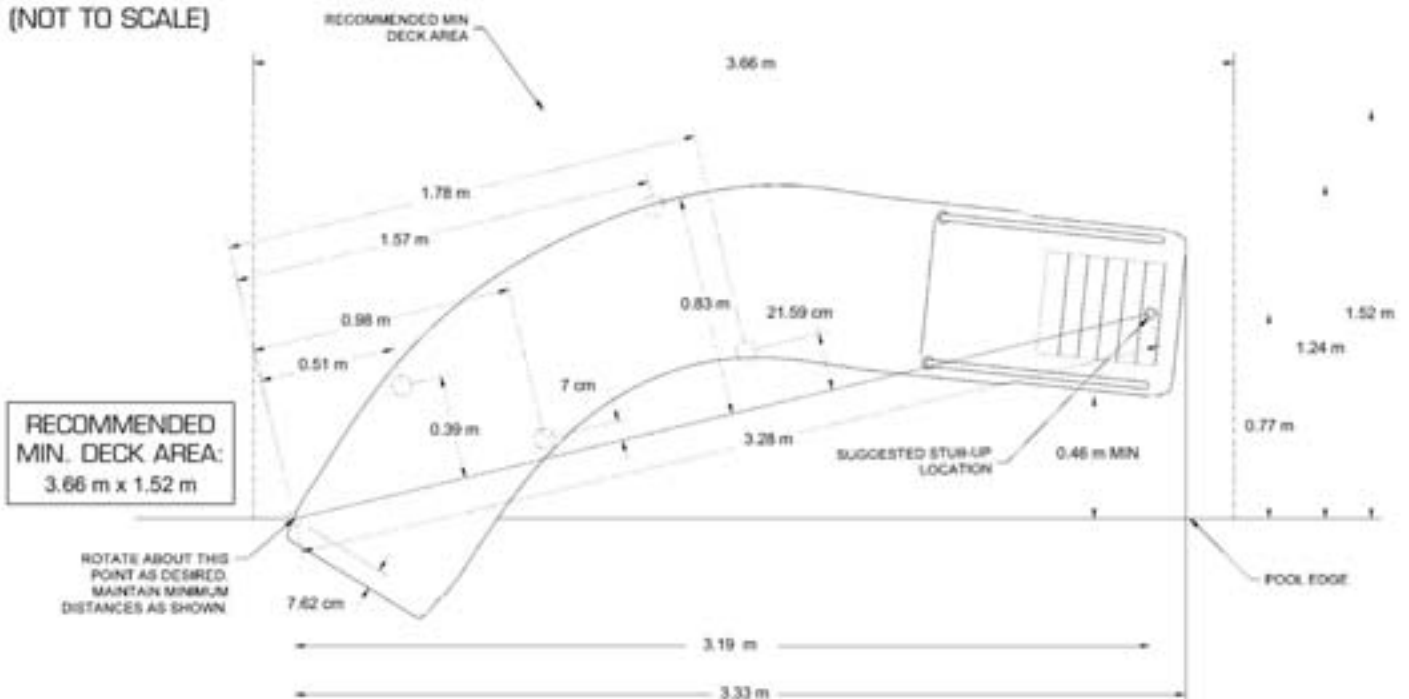

DIAGRAM E
(NOT TO SCALE)



SLIDE PLACEMENT DIAGRAM & FOOTPRINT DIAGRAM

Wild Ride Slide - Right Turn

DIAGRAM F
(NOT TO SCALE)

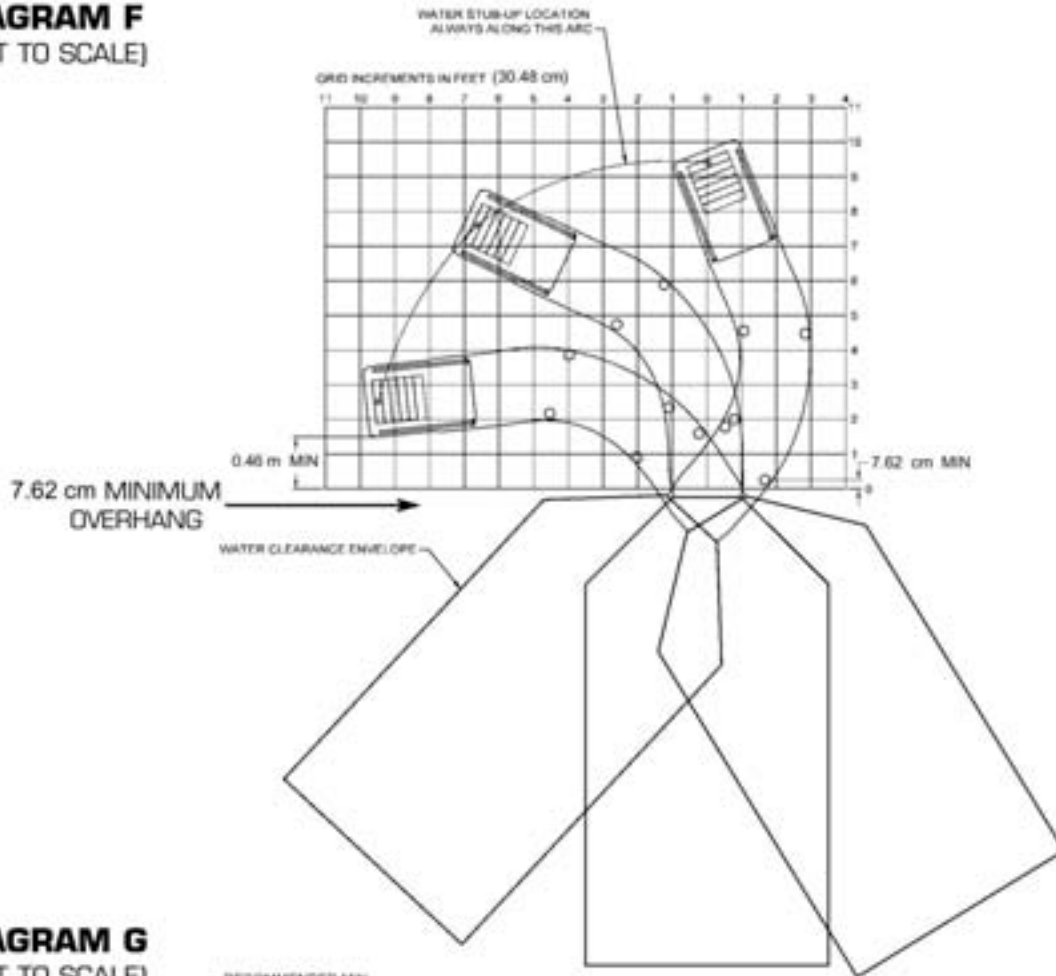
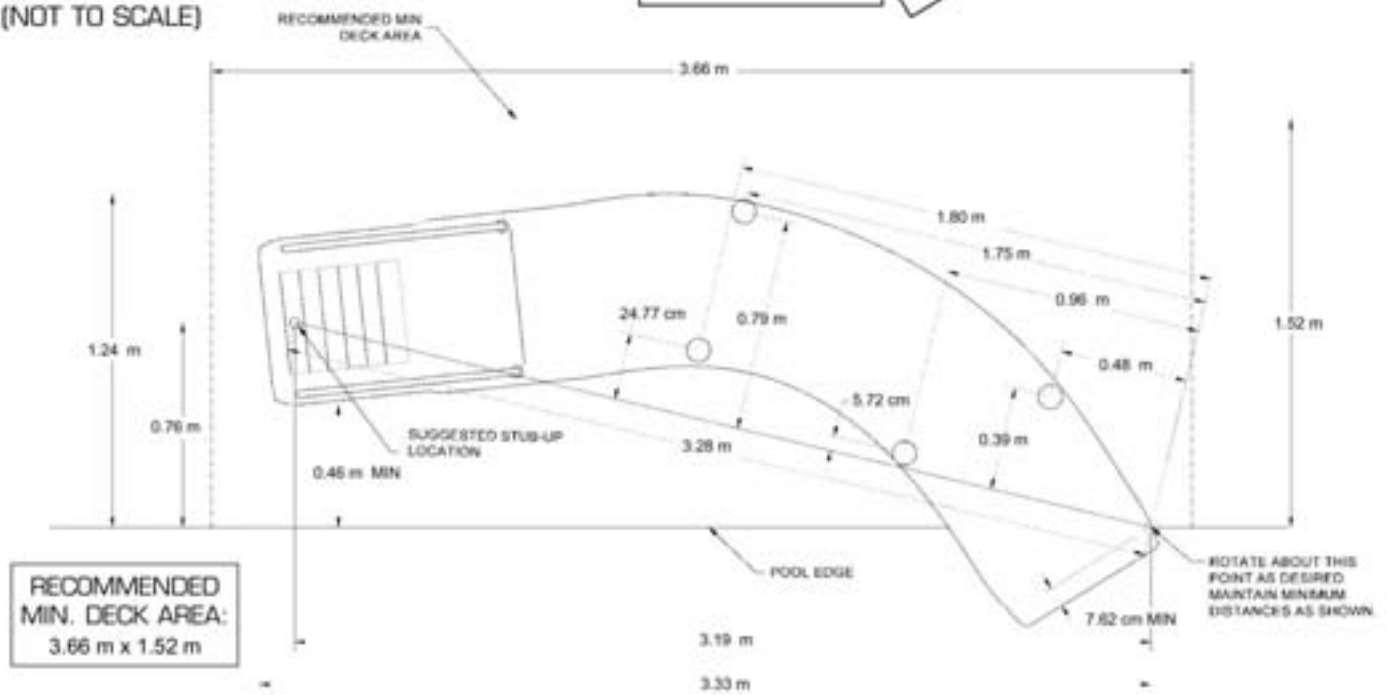

DIAGRAM G
(NOT TO SCALE)



RECOMMENDED TOOLS FOR ASSEMBLY AND INSTALLATION OF G-FORCE SLIDE:



ASSEMBLY TOOLS:

- Socket wrench
- 7/16", 9/16" & 3/4" sockets and extensions
- 7/16" & 9/16" wrenches
- 5/32" Allen wrench
- Hammer Drill
- 3/8" masonry drill bit (not shown)
- Vice Grips or Clamps (Optional: not shown)
- Step stool/ladder (not shown)
- Center Punch

NOTE: USE PROVIDED ANTI-SEIZE ON ALL BOLTS!

READ THIS ENTIRE INSTALLATION MANUAL BEFORE ATTEMPTING THE INSTALLATION

TIP: Use anti-seize (provided) on all bolts to minimize seizing hardware.

TIP: Use the box the slide came in to assemble the flume sections and step sections to keep them from being scratched.

TIP: Have rag handy to wipe the anti-seize off your finger or you will get it on the slide and it is difficult to get off.

TIP: Use vice grips or clamps to hold the flume sections as well as the step sections together during assembly.

For Technical Support or Assistance Contact Customer Service at:

**INTER-FAB, INC.
3050 S. ALVERNON WAY
TUCSON, AZ 85713
(800) 737-5386**

or visit: www.inter-fab.com

ASSEMBLY AND INSTALLATION INSTRUCTIONS

STEP ONE: Measure the Pool

Using the slide placement information on pages 4 and 5, choose the location and position for the slide. Next, measure the pool in front of where the slide will be installed and ensure it meets the minimum water safety envelope and clearance requirements.

Inter-Fab highly recommends that only the fully assembled slide be utilized to mark the locations for the anchor bolts.

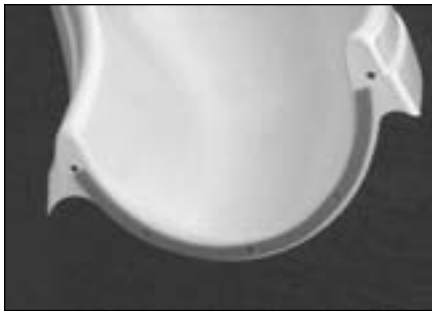

Fig. 1



Fig. 2



Fig. 3

STEP TWO: Assemble Flume Sections

TIP: Use the anti-seize (provided) on all bolts to prevent hardware from seizing.

Align the bolt holes in the flume flanges, use vice grips or clamps to hold the flanges in place. Using hardware kit SH-102-SS, in this order, take bolt, flat washer, push through both flanges, flat washer, then nut. (See Fig. 1, Fig. 2, and Fig. 3) **Hand tighten only at this point.**



Fig. 4



Fig. 5

STEP THREE: Attach Legs to Flume

TIP: Use the anti-seize (provided) on all bolts to prevent hardware from seizing.

The 2 longer legs attach to the upper flume section. The shortest leg attaches to the inside curve of the lower flume. (See Fig. 5)

Using hardware kit SH-102-SS, slip leg over the leg receiver on the flume. Align the predrilled holes, then in this order, take bolt, flat washer, push through leg and receiver, then flat washer, then nut.

INTER-FAB WILD RIDE SLIDE MUST BE INSTALLED USING THE PROVIDED STEEL DECK ANCHORS OR YOU WILL VOID THE WARRANTY.

STEP FOUR: Attach Deck Anchors to Legs

TIP: Use the anti-seize (provided) on all bolts to prevent hardware from seizing.

For On Deck Installation, slip the leg over a deck anchor as shown. (See Fig. 6) Align the predrilled holes in the leg with the lower hole in the deck anchor using hardware kit SH-106-SS. In this order take bolt, flat washer, push bolt through the leg and anchor, then add flat washer, then nut. Repeat this step for all 4 legs and tighten nuts.

TIP: You can find the SH-106-SS package inside the deck anchor. There is one for each anchor.

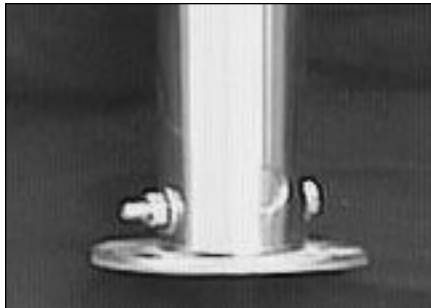

Fig. 6

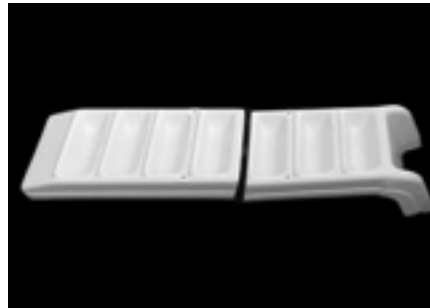

Fig. 7

STEP FIVE: Assemble Steps

TIP: Use the anti-seize (provided) on all bolts to prevent hardware from seizing.

Align the holes in the step sections, using a vice grip hold the 2 sections together, then using hardware kit SH-101-SS, in this order, take bolt, flat washer, push bolt through both step sections, then place flat washer, then nut. **Fully tighten the bolts, but do not over tighten.**

STEP SIX: Stand the Slide Up

Using 2 people to flip the slide over to its upright position. When you flip the slide make sure you hold the flume. **DO NOT HOLD THE LEGS TO FLIP THE SLIDE OVER.**

STEP SEVEN: Attach the “L” Brackets to Steps

Attach the “L” brackets to the inside bottom of the steps using hardware kit SH-103-SS. (See Fig. 8) When installed correctly, the brackets should sit flush with the bottom of the step sides. (See Fig. 9)

STEP EIGHT: Align Flume Sections

Align the flume sections for a smooth even sliding surface, then tighten all the flume bolts. **Do not over tighten.**



Fig. 8



Fig. 9

STEP NINE: Attach Handrails to Steps

TIP: Use the anti-seize (provided) on all bolts to prevent hardware from seizing.

Have one person lift the assembled steps, then position the upper portion of the handrail over the hole located on the outer edge of the step seat. (See Fig. 10) Then, using hardware kit SH-101-SS, and a 3/4" socket wrench with an extension, take bolt, then flat washer, thread bolt up from the underside into the handrail. **Do not fully tighten at this time.** Repeat this process for the other 3 handrail attachment positions on this rail, then repeat this process for the other handrail. (See Fig. 11)



Fig. 10



Fig. 11

STEP TEN: Attach Steps to Flume

TIP: Use the anti-seize (provided) on all bolts to prevent hardware from seizing.

Gently place the steps against the upper flume then align the holes in the step section with the holes in the flume. **TIP: Use a center punch or a screwdriver to gently align the bolt holes.** Then, using hardware kit SH-108-SS, insert the longer 3 allen head bolts in the 3 holes centered in the flume. (See Fig. 12) Then, from underneath, in this order, place flat washer, then nut. Then on the upper outside edge of the flume, insert the shorter allen head bolts, then add flat washer and nut. Fully tighten all the step to flume bolts at this time, but do not over tighten. (See Fig. 13) Next, fully tighten the handrail nuts.



Fig. 12

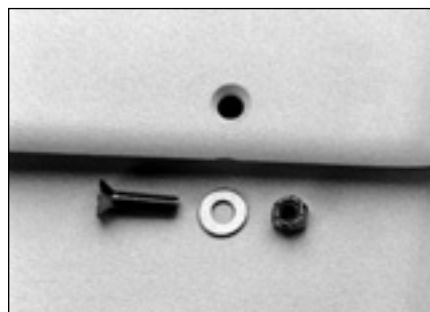

Fig. 13

STEP ELEVEN: Place Slide in its Correct and Final Position

Using 2 people, gently move the fully assembled slide to its correct and final position on the deck.

STEP TWELVE: On Deck Installation

Once the slide is in its final position then using a bubble level ensure the 4 legs are straight (plumb), next fully tighten the leg to flume bolts then using the deck anchor flange and the step "L" brackets as a template mark the locations for the anchor bolts. Gently move the slide to one side. Then using a 3/8" masonry drill bit and a hammer drill, drill a hole 4.45 cm - 5.08 cm deep, make sure you drill to the correct depth and make sure not to drill all the way through the deck. Gently hammer the bolt into the hole in the deck with 2 - 2.5 cm of the bolt above the deck. Gently lift and reposition the slide deck anchors and the "L" brackets over the bolts. Put anti-seize on the bolts, then flat washer and nut, secure the nuts on the bolts but do not over tighten. (See Fig. 14)

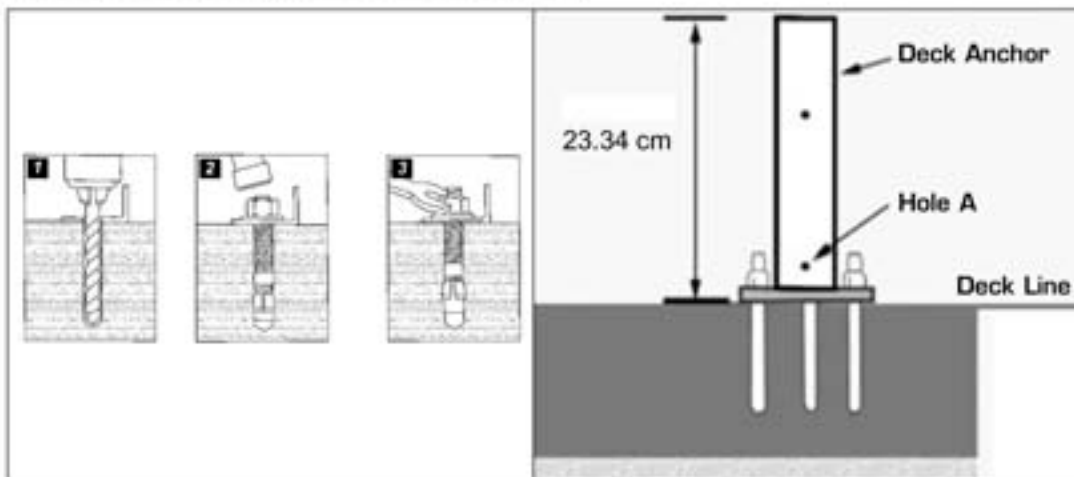

NOTE: If you are installing slide onto a deck using pavers, refer to optional Wild Ride Paver Kit info on page 13.

Fig. 14

STEP THIRTEEN: In Deck Installation

Attach slide legs to the higher of the 2 bolt holes on the deck anchor "hole B", make a mark with a marking pen or duct tape 10.8 cm from the bottom of the deck anchor, shim the legs so the mark you made on the deck anchor is flush with the finished deck, using a bubble level ensure the legs are plumb. Pour concrete to secure legs, ensure the proper footing depth is maintained under the deck anchor. (See Fig. 15)

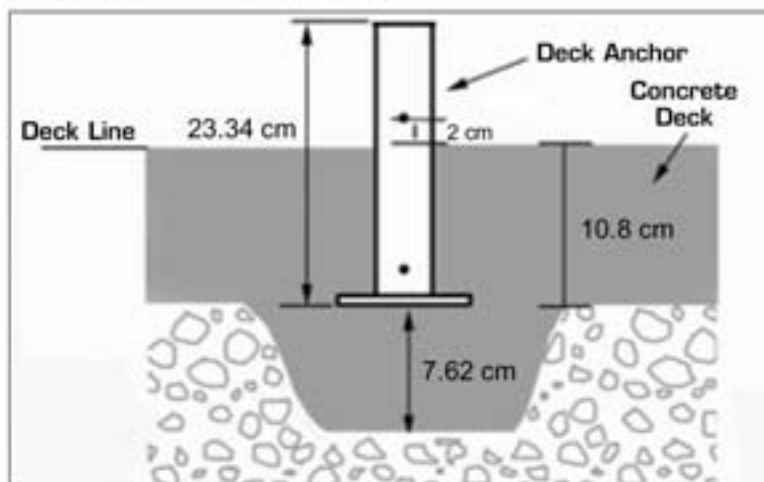

Fig. 15

STEP FOURTEEN: *Attach Water Supply to Slide*

Slip the provided 1” flex pipe through the hose hanger rings along the underside of the step. You can use either the right or the left hand side. Then slip it through the underside of the seat. (See Fig. 16)

Using PVC glue attach the flex pipe to the water supply fitting under the flume. (See Fig. 17)

Using PVC glue attach on/off ball valve near the deck above the water stub up. (See Fig. 18)



Fig. 16



Fig. 17



Fig. 18

STEP FIFTEEN: *Attach Protective Caps*

Ensure that all bolts are securely tightened.

Place a protective rubber cap over each exposed bolt and nut.

STEP SIXTEEN: *Give the Owner’s Manual to Homeowner*

Give the homeowner the Owner’s manual and go over the intended use instructions with them.

FINAL & ANNUAL INSPECTION CHECK LIST:

1. Inspect the runway for visible cracks or tears.
2. Inspect the edges of runway for sharpness, loose cracks or tears.
3. Inspect the slide for loose or corroded fasteners.
4. Inspect all step-attachment points for evidence of shear, bending, yield or fatigue. Yield is evidenced by crystallization or fine cracking of the ladder tread or surface.
5. Inspect the ladder handrails for rigidity and attachment; can they be pulled out of their sockets.
6. Inspect the slide for sharp edges or protrusions on the ladder, deck flanges, handrails or runway.
7. Measure the depth of the water in front of the slide exit and measure height of exit and compare to Diagrams A, B and C on page 3.
8. Check the position of the slide exit to Diagrams D, E, F and G on pages 4 and 5.
9. Make sure the slide warning label is securely adhered to the slide.
10. Personally Give the owner’s manual to the customer and go over the **INTENDED USE INSTRUCTIONS** with them.

SLIDE CARE & MAINTENANCE: **ACRYLIC & POLYETHYLENE COMPONENTS -**

1: General Cleaning

- Use nonabrasive soap and water when possible.
- Review cleaner's label instructions before applying to acrylic surface.
- Avoid harsh chemicals and disinfectants.

You may safely use: *

- Chlorox
- Spic & Span Powder
- Mr. Clean
- Formula 409
- Windex
- Glass Plus
- Calgon Bath Oil Beads

Do not use:

- Lysol Disinfectant Spray
- Dow Disinfectant Bathroom Cleaner
- Pinesol
- Whitecap
- Lestoil

2: Light scratches, abrasions, gloss, etc.

Light abrasions and scratches may be removed and original gloss fully restored using the following materials. *

- Novus Plastic Polish (Novus, Inc.)
- Mirror Glaze Professional Formula #17 (Mirror Bright Polish Co., Irvine, CA)
- Permatex Plastic Cleaner #403D (Permatex Co., Kansas City, KS)
- "J-Wax" or "Kit" Automotive Cleaner/Waxes (S.C. Johnson & Son)
- DuPont or Turtlewax "White Polish" automotive polishing compound.

Light Scratches: Very light scratches, scuff marks and haze can be hand polished with Permatex Plastic Cleaner or Gel-Glass. Follow the manufacturer's guidelines. Clean cotton cloth works best for applying the polish and buffing. *

***These suggestions and data based on information we believe to be reliable, from our acrylic manufacturer. They are offered in good faith, but without guarantee, as conditions and methods of use and procedures are beyond our control.**

PAVER KIT INFO – WILD RIDE SLIDE

When installing an Inter-Fab Wild Ride™ slide using a paver kit, you must ensure that all standard installation requirements are met. The slide must be compatible with the type of pool on the intended installation and all ANSI/NSPI-2003 requirements must be met. Refer to installation manual.

Figure 19 illustrates an example of the minimum concrete pads recommended for the and Wild Ride™ slides. Specific slide position and concrete pad orientations may vary. Make sure to allow for water stub up location near the ladder section of the or Wild Ride™ slide when pouring the concrete pad for the ladder section. *In order to ensure proper placement, you will need to set the slide up first to determine where the concrete pillars will be located.*

Figure 20 shows a side view illustration of the or Wild Ride™ slide foot deck anchor and wedge anchors used in a paver installation. Pavers can be a maximum of 7.62 cm thick. Pavers must be mechanically attached to the concrete pad using a setting material (such as mortar or thinset for example) that is no thicker than 0.95 cm.

2.54 cm of the 3/8" x 17.78 cm wedge anchor (14 ea.) needs to be exposed above the final deck surface. The 3/8" wedge anchors must be drilled to a depth of 15.24 cm with a 2.54 cm of the bolt left remaining above the final deck surface. The 3/8" x 17.78 cm wedge anchors (14 ea.) replace the 3/8" x 7 cm wedge anchors (2 ea.) from hardware kit #SH-108 and the 3/8" x 7 cm wedge anchors (12 ea.) from hardware kit #sh-106. You will need to factor in the thickness of your paver (7.62 cm MAX) and the thickness of your setting material (0.95 cm MAX) for your individual installation.

You will need a 3/8" masonry bit for the or Wild Ride™ slide.

Inter-Fab Inc. will not be responsible for damage to pavers caused by drilling or mechanically attaching to concrete pad. Refer to paver manufacturer's specific installation instructions before beginning.

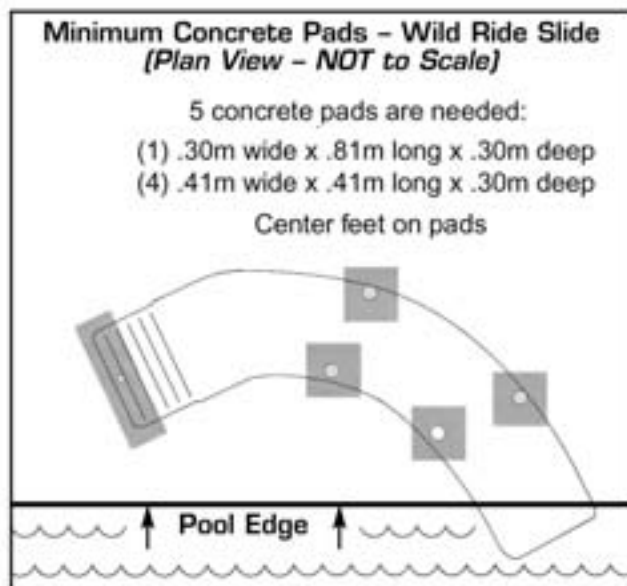

Fig. 19

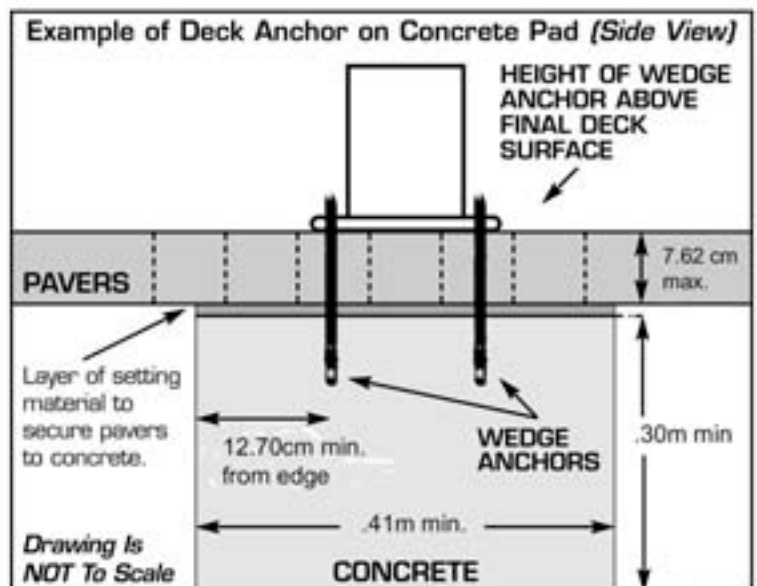
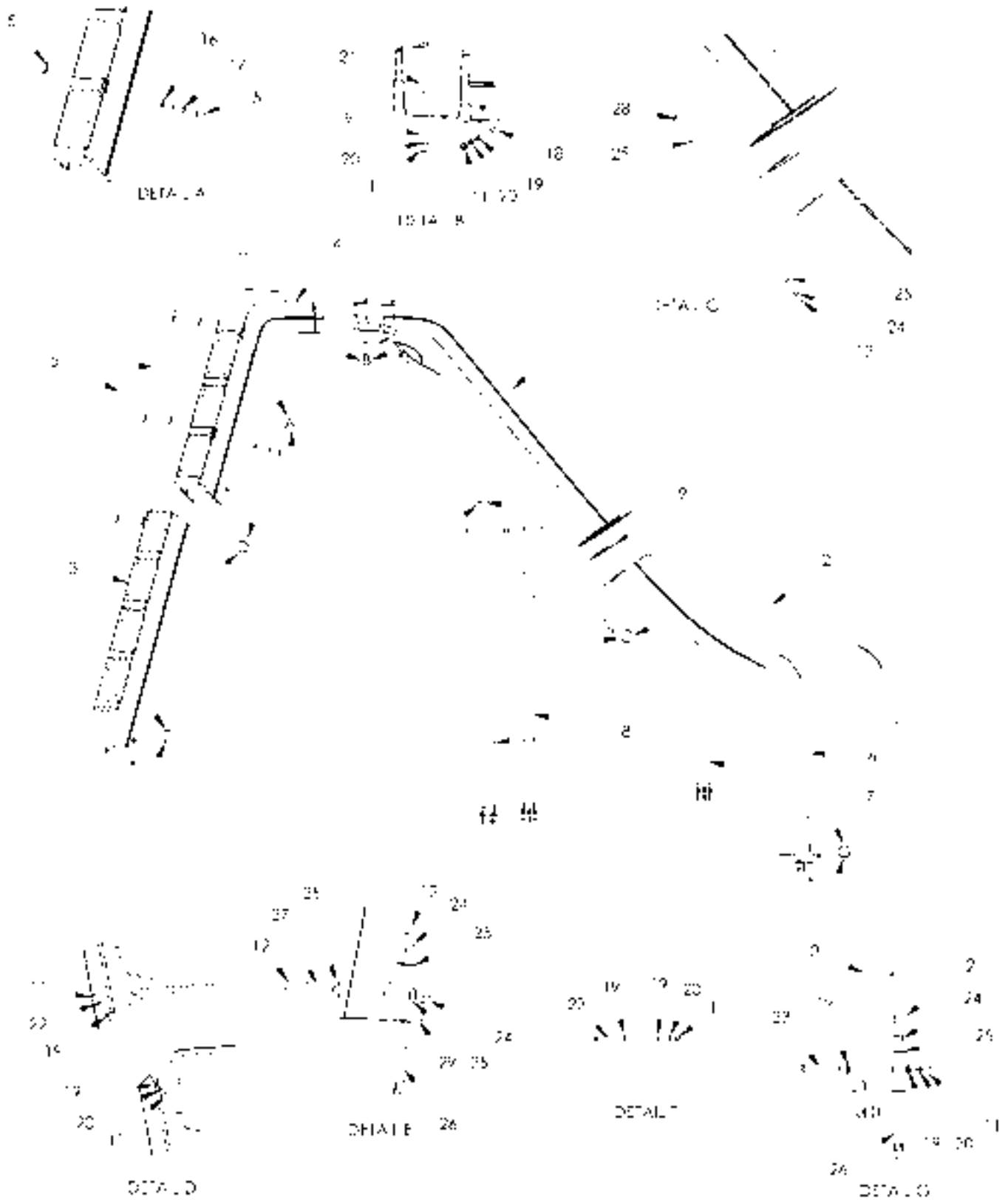

Fig. 20

WILD RIDE™ SLIDE (W-RIDE-CR-SS):



WILD RIDE™ SLIDE (W-RIDE-CR-SS):

ALL CHART INFORMATION BELOW CORRESPONDS WITH THE DRAWING ON THE PREVIOUS PAGE.



HARDWARE NOTE:
Use a small dab of anti seize lubricant (included) on all bolt threads.

DRAWING REPRESENTS THE FOLLOWING PART NUMBERS:

W-RIDE-CL-SS	W-RIDE-CR-SS (shown)
--------------	----------------------

ITEM #	COMPONENT	DESCRIPTION	HARDWARE KITS/PARTS KITS – QTY. COUNTS											
			SH-101	SH-102	SH-103	SH-104	SH-106	SH-107	SH-108	HOSE	WRS			
1	WRS-URUN-W-R	WILD RIDE UPPER RUNWAY												1
2	WRS-LRUN-W-R	WILD RIDE LOWER RUNWAY												1
3	WRS-LSTEP-W	WILD RIDE STEP LOWER SECTION												1
4	WRS-USTEP-W	WILD RIDE STEP UPPER SECTION												1
5	WRS-HD RAIL	WILD RIDE HANDRAIL												2
6	WW-24-1/2"-LEG	LEG, 24-1/2"												1
7	WW-22"-LEG	LEG, 22"												1
8	WW-54-1/2"-LEG	LEG, 54-1/2"												2
9	H-WRS GASKET	GASKET, CLOSED CELL NEOPRENE SPONGE												1
10	DECK ANCHOR	9" STAINLESS STEEL DECK ANCHOR								4				
11	H-.463 X .310 CAP	.463 X .310 PROTECTIVE CAP				25	1							
12	H-.562 X .390 CAP	.562 X .390 PROTECTIVE CAP				15	3							
13	H-1 BALL VALVE	1" BALL VALVE-SLIP WHITE											1*	
14	H-1 SPA HOSE	10 FEET OF 1" PVC FLEX PIPE											1*	
15	H-1 WHT CAP	.750 X 1" GRAY NUT CAP				6								
16	H-SS 1/2 F WAS	1/2" FLAT WASHER S.S.	8											
17	H-SS 1/2-13 BOL	1/2" X 1-1/2" HEX HEAD BOLT S.S.	8											
18	H-SS 1/4 FL HEAD	1/4-20 X 3/4" SOC FLAT C/S SS									2			
19	H-SS 1/4 FLAT W	1/4" FLAT WASHER SS 18.8	17	8				2						
20	H-SS 1/4 H NUT	1/4" HEX NUT SS	11	4			1							
21	H-SS 1/4 X 1-1/4 F	1/4-20 X 1-1/4" SOC FLAT C/S 1									3			
22	H-SS 1/4-20 X 1	1/4" X 1" HEX HEAD BOLT S.S.	6											
23	H-SS 1/4X2-1/4H	1/4" X 2-1/4" HEX HEAD BOLT S.S.		4				1						
24	H-SS 3/8 F NUT	3/8" HEX NUT SS		6	2			3						
25	H-SS 3/8 FLT WASHER	3/8" X 1" FLAT WASHER S.S.		12	4			3						
26	H-SS 3/8 WEDGE	3/8 X 2-3/4 WEDGE ANCHOR ST.ST			2			3						
27	H-SS 3/8X1 H B	3/8" X 1" HEX HEAD BOLT S.S.			2									
28	H-SS 3/8X1-3/4	3/8" X 1-3/4" HEX HEAD BOLT S.S.		6										
29	L-BRACKET	L-BRACKET, LADDER ANCHOR, WHITE									2			
30	H-ANTI-SEIZE	ANTI-SEIZE PACKET												1

* not pictured

NOTES:

Wild Ride Slides available in both right and left turns.
Wild Ride slides available with custom powder coated handrails and legs.

WILD RIDE™ SLIDE HARDWARE KITS

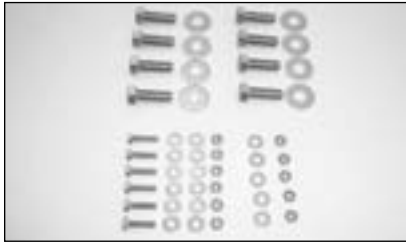

SH-101-SS – STEP AND HANDRAIL ASSEMBLY		
QTY	PART NUMBER	COMPONENT DESCRIPTION
6	H-SS 1/4-20 X 1	1/4" x 1" hex head bolt s.s.
8	H-SS 1/2-13 BQL	1/2" x 1-1/2" hex head bolt s.s.
11	H-SS 1/4 H NUT	1/4" finish hex nut s.s.
17	H-SS 1/4 FLAT W	1/4" flat washer s.s.
8	H-SS 1/2 F WAS	1/2" flat washer s.s.

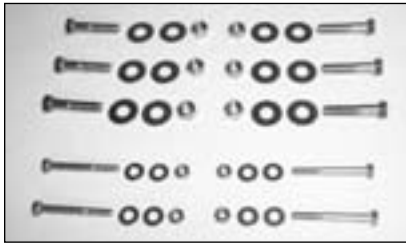

SH-102-SS – FLUME AND LEG ASSEMBLY		
QTY	PART NUMBER	COMPONENT DESCRIPTION
4	H-SS 1/4X2-1/4H	1/4" x 2-1/4" hex head bolt s.s.
6	H-SS 3/8X1-3/4	3/8" x 1-3/4" hex head bolt s.s.
4	H-SS 1/4 H NUT	1/4" finish hex nut s.s.
6	H-SS 3/8 F NUT	3/8" finish hex nut s.s.
8	H-SS 1/4 FLAT W	1/4" flat washer s.s.
12	H-SS 3/8 FLT WASHER	3/8" x 1" flat washer s.s.

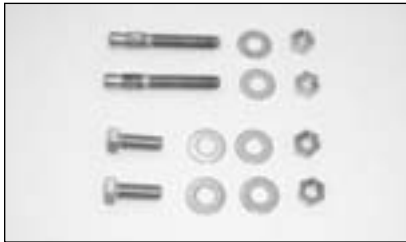

SH-103-SS – STEP TO DECK		
QTY	PART NUMBER	COMPONENT DESCRIPTION
2	H-SS 3/8X1 H B	3/8" x 1" hex head bolt s.s.
2	H-SS 3/8 F NUT	3/8" finish hex nut s.s.
4	H-SS 3/8 FLT WASHER	3/8" x 1" flat washer s.s.
2	H-SS 3/8 WEDGE	3/8" x 2-3/4" wedge anchor w/nut & flat washer s.s.

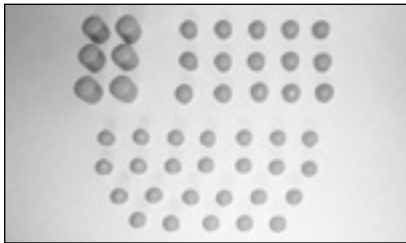

SH-104 – GRAY PROTECTIVE CAPS		
QTY	PART NUMBER	COMPONENT DESCRIPTION
6	H-1 WHT CAP	gray protective cap (1/2" bolt)
15	H-.562 X.390 CAP	gray protective cap (3/8" bolt/nut)
25	H-.463 X .310 CAP	gray protective caps (1/4" bolts/nuts)



SH-106 – DECK ANCHOR HARDWARE		
QTY	PART NUMBER	COMPONENT DESCRIPTION
1	H-SS 1/4X2-1/4H	1/4" x 2-1/4" hex head bolt s.s.
3	H-SS 3/8 WEDGE	3/8" x 2-3/4" wedge anchor w/nut & flat washer s.s.
1	H-.463 X .310 CAP	gray protective caps (1/4" bolts/nuts)
3	H-.562 X.390 CAP	gray protective cap (3/8" bolt/nut)
2	H-SS 1/4 FLAT W	1/4" flat washer s.s.
1	H-SS 1/4 H NUT	1/4" finish hex nut s.s.



SH-107 – DECK ANCHOR ASSEMBLY		
QTY	PART NUMBER	COMPONENT DESCRIPTION
1	SH-106	SH-106 kit
1	WIP-WWS-DA	9" s.s. deck anchor



SH-108 – SLIDE STEP ANCHOR		
QTY	PART NUMBER	COMPONENT DESCRIPTION
2	WIP-108-PC	Ladder anchor painted
2	H-SS 1/4 FL HEA	1/4" x 3/4" socket head cap screw painted
3	H-SS 1/4X1-1/4F	1/4" x 1-1/4" socket head cap screw painted



LIMITED WARRANTY

Inter-Fab, Inc. will repair or replace, at its option, any product manufactured by Inter-Fab, Inc. that fails during the applicable warranty period because of a manufacturing or material defect; provided that the defect is not the result of improper installation, improper use or care, negligence, alterations or modifications to the product, or natural accidents (acts of God). The applicable warranty period for products manufactured by Inter-Fab, Inc. is three (3) years from the date of retail purchase, except as specified below:

Echoes of Nature™ products are individually handcrafted and painted by skilled artisans and as a result, dimensional differences and color variations are normal and are not a basis for warranty coverage. The warranty period for pumps sold with the Echoes of Nature™ products is three (3) years from the date of retail purchase.

Water Sports™ sports equipment warranty periods are as follows: Volleyball Poles, Basketball Posts, Basketball Rim, and Basketball Backboard one (1) year from date of retail purchase; and Volleyball, Volleyball Net, Basketball, Basketball Net, and Pumps are warranted for ninety (90) days from date of retail purchase.

T7™ Edgewater™ and Lighted Edgewater™ features warranty period is one (1) year from date of retail purchase.

Zoomerang™ slide products warranty period is one (1) year from the date of retail purchase.

Build Your Own Slide™ (BYOS™) warranty period is one (1) year from the date of retail purchase.

City 2™ Slide and **City Base™** products warranty period are one (1) year from the date of retail purchase.

Unless expressly stated otherwise all products manufactured by Inter-Fab are for residential installation and use only. Inter-Fab, Inc. expressly disclaims any and all warranties and liability arising from the installation or use of its residential products used in a commercial application. Products expressly manufactured for commercial installation and use will be subject to this limited warranty.

This limited warranty is in lieu of all other warranties, whether express or implied. Inter-Fab, Inc. disclaims any warranty of merchantability or fitness for a particular use, and noninfringement in relation to any of its products and Inter-Fab, Inc. is not liable for consequential, incidental or specific damages. This warranty is limited to the repair or replacement of the manufacturing or material defect, or refund of the original purchase price, whichever is less, at the sole option of Inter-Fab, Inc., and expressly does not cover any labor or reinstallation expenses related to the replacement of any and all Inter-Fab products. This limited warranty shall be the sole and exclusive remedy of irrespective of whether the claims are made in contract, tort, warranty, law, equity or by statute.

This warranty is to the original purchaser of the product only. Inter-Fab's limited warranty is neither transferable nor portable from consumer to consumer. The effective coverage date begins at the date of retail purchase. Product owner or representative must notify Inter-Fab, Inc. (or its wholesale agent) in writing, giving a full description of the nature of the product defect or failure along with proof of purchase, serial number(s) of the product and photos within thirty (30) days of the expiration of the applicable warranty period. Inter-Fab, Inc. reserves the right to physically inspect damaged or defective products or components to determine the cause of the damage or defect, prior to authorizing repair or replacement of its products.

CUSTOMER SERVICE/TECHNICAL SUPPORT – Mon – Fri: 7am – 4pm MST
520.790.7040 • 800.737.5386 • Fax 520.790.7127 • inter-fab.com
3050 S. Alvernon Way • Tucson, AZ 85713 • customerservice@inter-fab.com